

CM 280

Gru idraulica a montaggio rapido
Hydraulic crane with quick assembling
Grue hydraulique à montage rapide
Hydraulischer Schnellmontagekran
Grúa hidráulica de montaje rápido















EN 14439 C25

DIN 15018-H1/B3

PROGETTO e COSTRUZIONE / DESIGN and CONSTRUCTION:
LUIGI CATTANEO S.p.A

Prestazioni - Performances - Prestations - Leistungen - Prestaciones

  kVA	 230V - 50Hz				 230V - 50Hz				 400V - 50Hz			
			(3 kVA) 1 4,5 kVA) 2				(6 kVA) 3 10 kVA) 4				(6 kVA) 3 10 kVA) 4	
 inverter 7,5/1400	kW/g/min 7,5/1400		m/min	5	18 (12)	26 (18)		m/min	5	18 (12)	40 (32)	
			kg	2.200	1.000	600		kg	2.200	2.200	600	
			m/min	5	18	40		m/min	5	18	40	
			kg	2.200	2.200	600		kg	2.200	2.200	600	
 inverter	2,2/1400	m/min 20 - 35				m/min 20 - 40						
 inverter	2,2/1400	g/min				0,4 - 0,9						

  kVA	 400V - 50Hz						
			12 kVA) 5				
 inverter 7,5/1400	kW/g/min 7,5/1400		m/min	5	18	30	40
			kg	2.500	2.500	1500	1000
			 inverter	3/1400	m/min 25 - 50		
 inverter	2,2/1400	g/min 0,4 - 0,9					

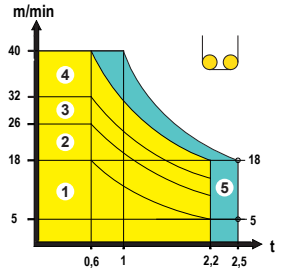

Montaggio - Erection - Montage - Montage - Montage

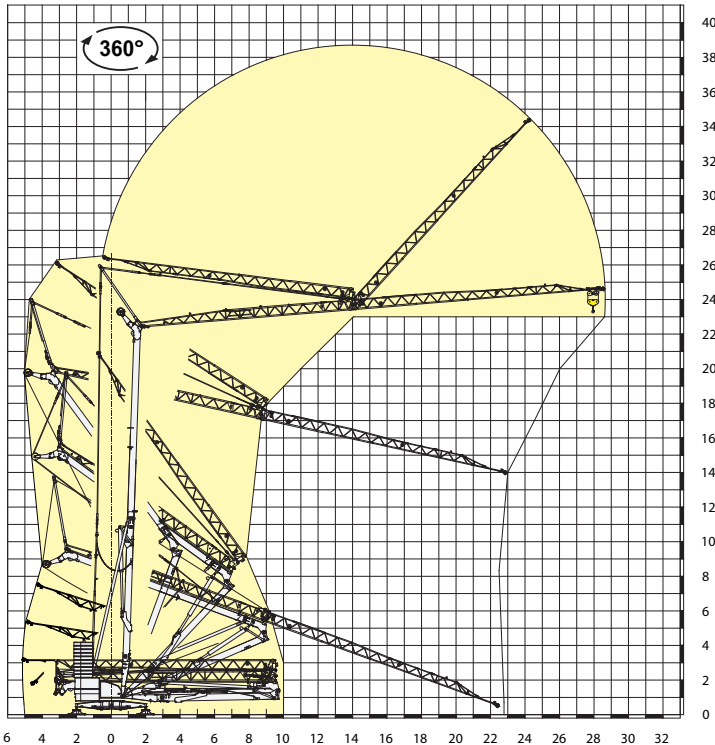

Contrappeso in lastre di cemento armato - Ferro-concrete ballast slabs Contrepoids en plaques de béton armé - Gegengewicht aus Betonplatten - Lastre en hormigón armado

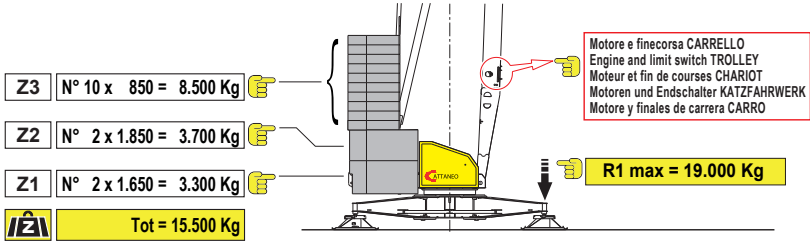

Trasporto - Transport - Transport - Transport - Transporte

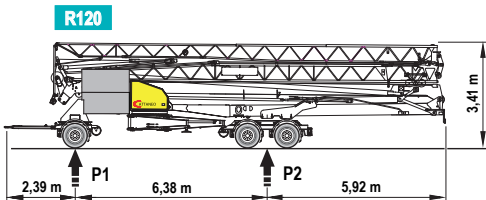
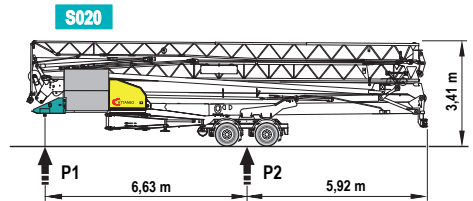
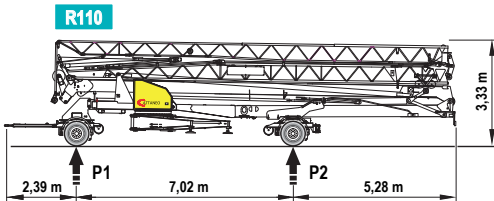
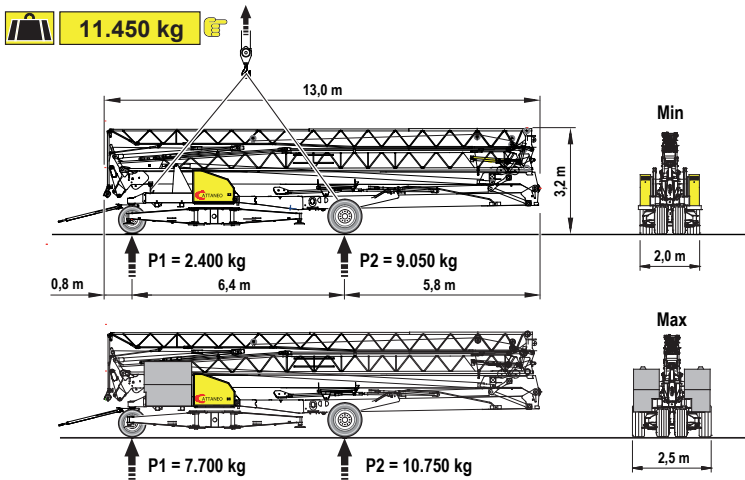

Otto	km/h	P1	P2	
R110	80	4.100	8.800	kg
R120	80	9.050	11.850	kg
S020	80	8.050	11.850	kg

Dir. 2007/46/CE